

## IACT16I-XXX SERIES

IACTXXI series is a split core current transformer for the electronic measurement of AC waveform current with galvanic separation between the primary current and the secondary output voltage.

IACTXXI series is an ideal CTid built-in split-core current transformer for JAGUAR IoT meters, and its ratio error and phase displacement are fully tested with IEC 61869-2 standards accuracy Class 1.0 and IEEE/ANSI C57.13 Class 1.2.



### Features

- Rated current: 50 and 100 amps
- Monitoring-grade: 1.0% accuracy
- Compact and low weight
- Opening: 0.63 x 0.63 inches (16 x 16 mm)

### Standards

- UL Listed (UL 2808, XOBA) for field installation
- UL/EN61010-1(PICQ) : Pollution Degree: 2 CAT III, 600 Vac
- IEC 61869-2 standards accuracy Class 1.0 and IEEE/ANSI C57.13 Class 1.2



Model	Rated Amps	Output	Accuracy	Internal Burden (Ohms)
IACT16I-050	50A	0.3333 Vac	1%	20.15
IACT16I-100	100A	0.3333 Vac	1%	10.09

Note: the burden resistor is built into the IACT16I-XXX SERIES.

### How to Use

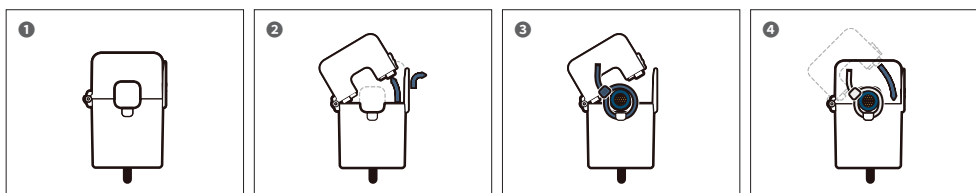

Please refer to "Split-core Current Transformer Installation Guide" for further details.

## 1. Specifications

- **Line Frequency** : 50 to 60 Hz
- **Maximum Continuous Primary Current** : 120 amps
- **Maximum Voltage** : 600 Vac
- **Overvoltage and Measurement Category** : CAT III: 600 Vac
- **Output Lead Wires** :
  - Standard length : 8 ft (2.44 m)
  - Gauge : #26 AWG
- **Voltage** : 600 Vac
- **Output** : Voltage output, integral burden resistor
  - Output Voltage at Rated Amps: 333 mV
  - Output Protection: includes internal burden resistor

### 1.1 Accuracy

- **Ratio Error** :
  - Accuracy 1.0% conforms to IEC 61869-2 & IEEE/ANSI C57.13 meets the measuring range from 1% to 120% of  $I_n$
- **Phase Angle** :
  - 50/60 Hz – 0.0 to 1.0 degrees leading from 1% to 120% of rated current

### 1.2 Regulatory

- CE
- UL/EN61010-1(PICQ) : Pollution Degree: 2 CAT III, 600 Vac
- RoHs Compliant

### 1.3 Environmental

- **Operating Temperature** : -20°C to +55°C (-4°F to +131°F)
- **Operating Humidity** : Non-condensing, 0 to 95% relative humidity(RH)
- **Operating Altitude** : Up to 2000 m (6561 feet)
- **Pollution Degree** : 2 (controlled environment)
- **Indoor Use** : Suitable for indoor use

### 1.4 Mechanical

- **Width** : 1.18 inches (30 mm)
- **Height** : 1.78 inches (45.2 mm)
- **Thickness** : 1.24 inches (31.6 mm)
- **Opening** : 0.63 inches (16 mm)
- **Weight** : 104.03(±3) g
- **Core material** : high permeability ferrite

Dimensions IACT16I-XXX SERIES

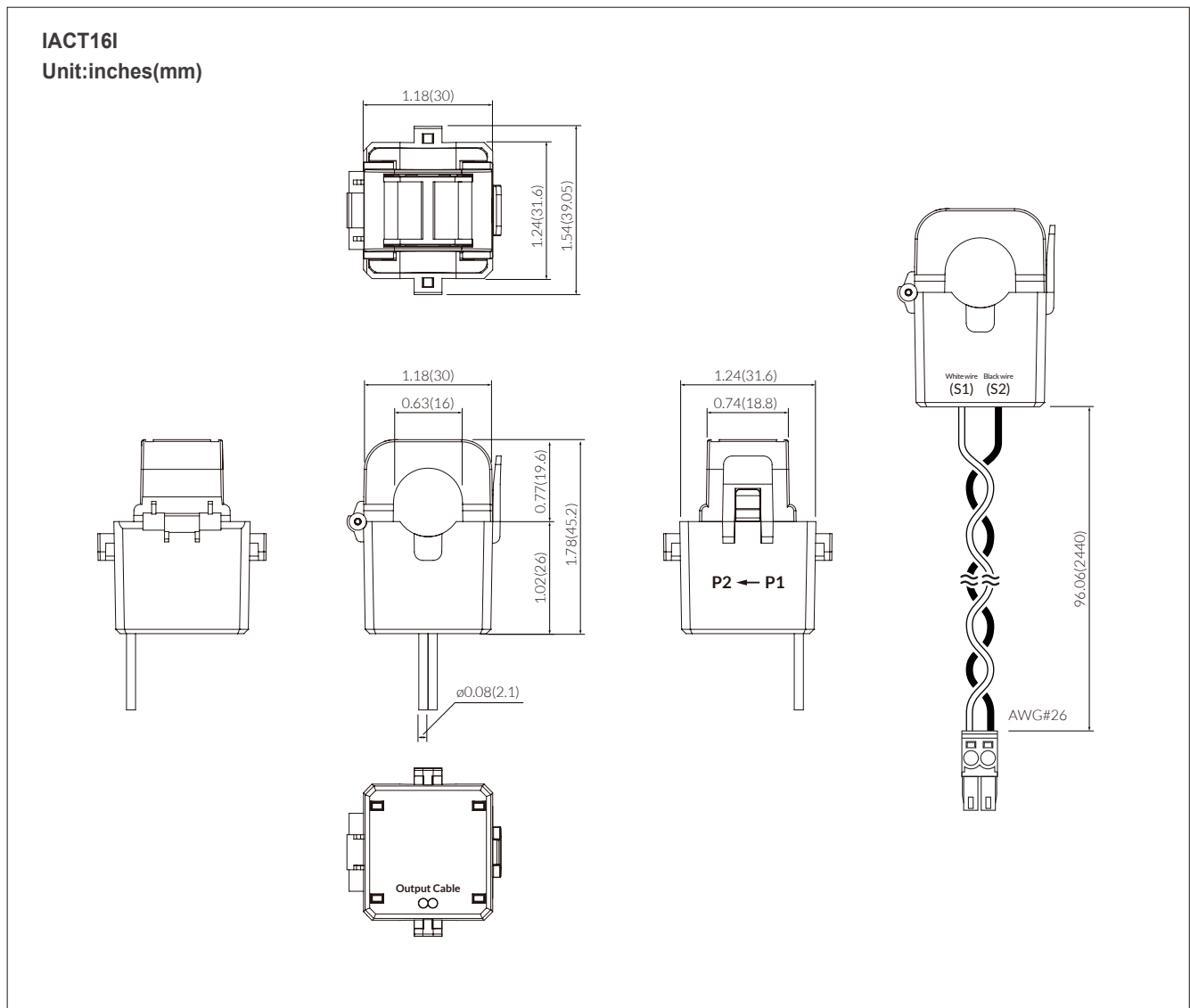

1.5 Labels

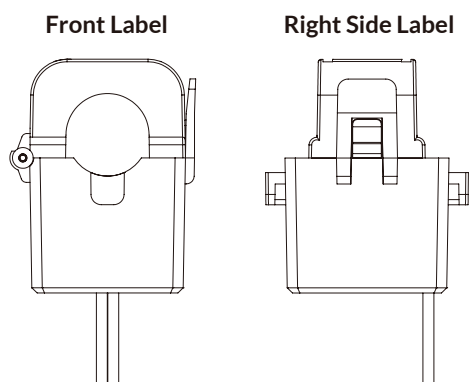

- Orientation : Mount the CT referring to the right side label attached(P1->P2).

### 1.6 Connection

Unit: inches(mm)

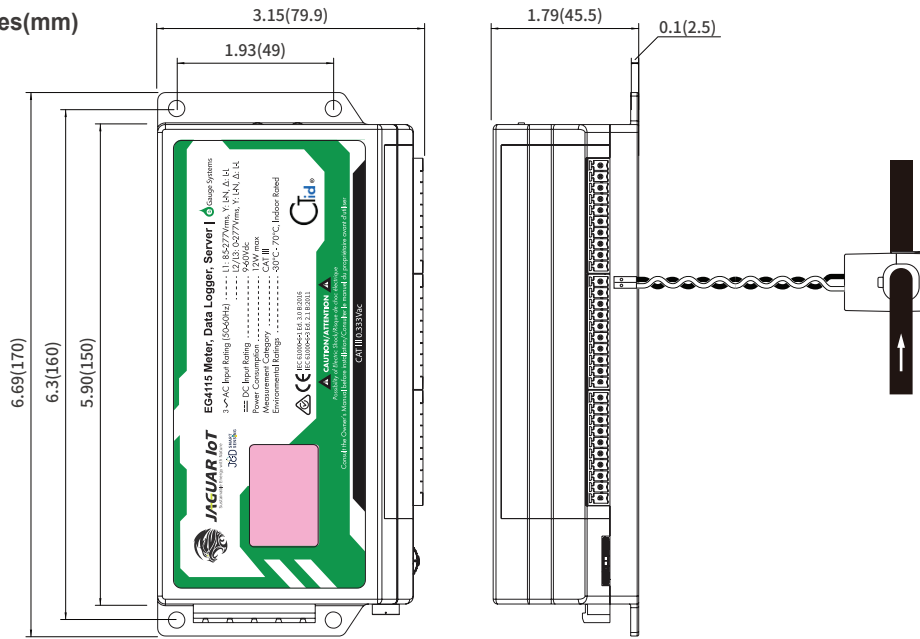

• CT housing color options : Black, White

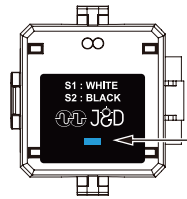

LED light flashes when commanded through the interface.

### 1.7 Schematic Diagram

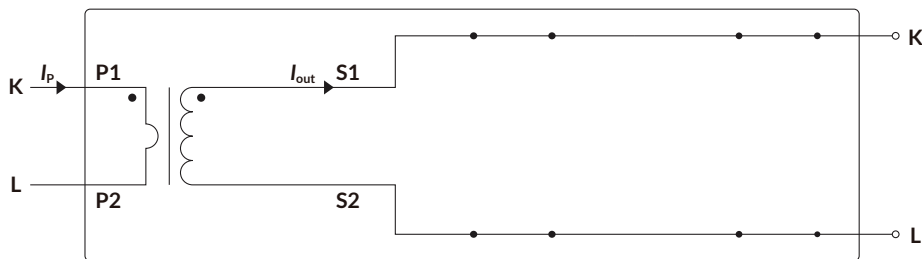

## 2. Typical Accuracy

- In the following graphs, a positive phase angle error indicates that the output of the CT leads the primary current.
- Graphs show typical performance at 25°C(77°F), 50/60 Hz

### 2.1 IACT16I-050

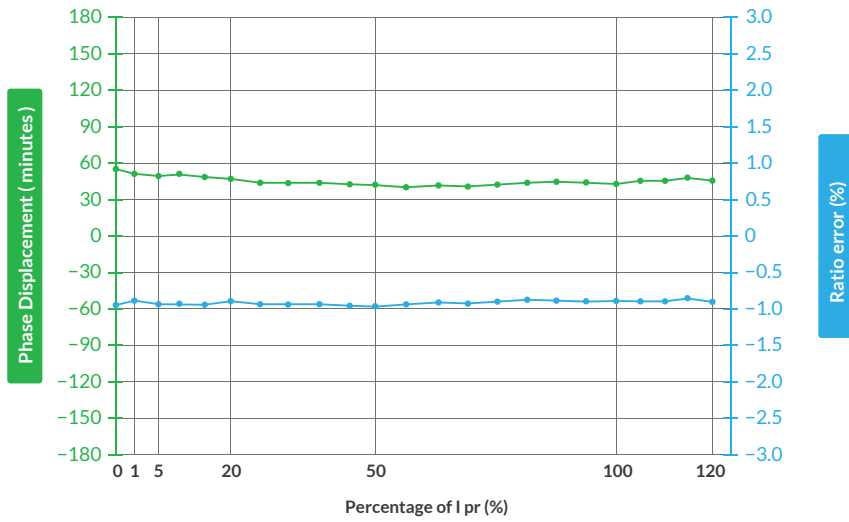

### 2.2 IACT16I-100

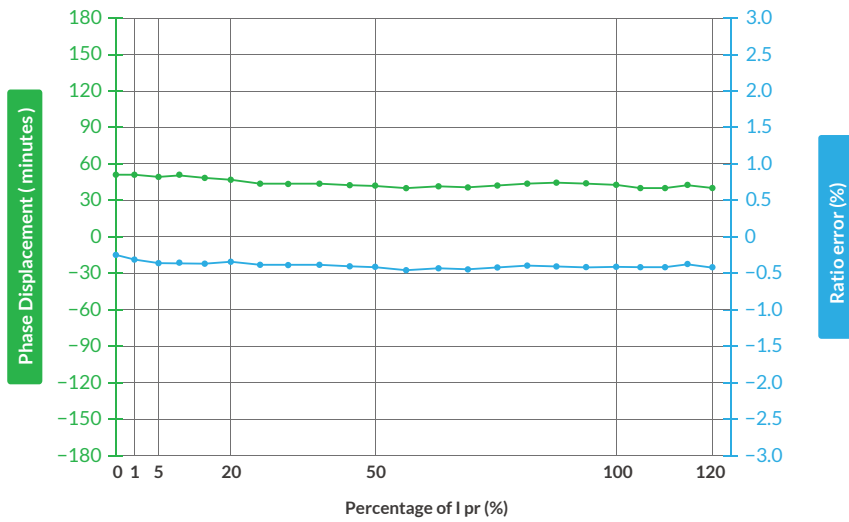

### 3. Safety

The J&D CTs are UL/EN 61010-1, CE, RoHS compliant and certified, are also conformed up to Pollution degree 2, 600Vac CAT III rated devices.



Please be sure that Failure to follow these instructions can result in serious injury and/or cause damage.

The transducer shall be used in electric/electronic equipment in accordance with the operating instructions of all related systems and component manufacturers with respect to applicable standards and safety requirements.

Follow corresponding national regulations and safe electrical work practices.

This equipment must only be installed and serviced by qualified personnel. And the qualified personnel is one who has skills and knowledge related to the construction and operation of this electrical equipment and installations, and has received safety training to recognize and avoid the hazards involved.



When operating the transducer, there may be dangerous active voltages (e.g. primary conductor) in certain parts of the module. Users should make sure to take all necessary steps to protect against electric shock. The transducer is a built-in device containing conductive parts that are inaccessible after installation.

Therefore, a protective enclosure or additional insulation barrier is necessary.

Safe and trouble-free operation of this converter can only be guaranteed if transport, storage and installation are carried out correctly and operation and maintenance are carried out carefully.

### 4. Remark

- $V_o$  is positive when  $I_p$  flows in the direction of the arrow. (o : output, p : primary current)
- Temperature of the primary conductor should not exceed 55°C(131°F).
- Dynamic performances (di/dt and delay time) are the best with a single bar when the primary hole is completely filled.

### 5. Attention

Contact areas (air gap) must be kept clean (particle free) to ensure proper performance.